

ASSEMBLY AND OPERATING INSTRUCTIONS



CONTENTS

I About The Product

- 1-1 Product Information 2
- 1-2 Parts List 4

III Appendix

- 3-1 User's Manual 17
- 3-2 After-sales Service 18
- 3-3 Product Maintenance 18
- 3-4 Disclaimer 19
- 3-5 More Products 20

II Installation Steps

- 2-1 Safety Tips 7
- 2-2 Inspection And Acceptance 7
- 2-3 Install The Frame 8
- 2-4 Install The Top 10

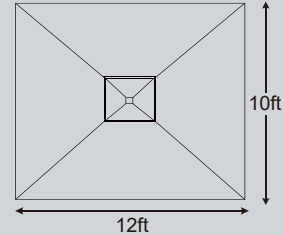
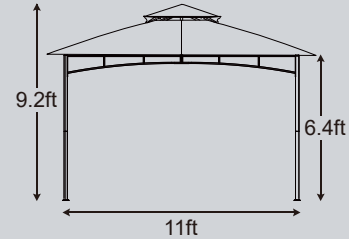
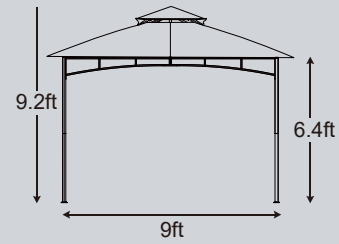
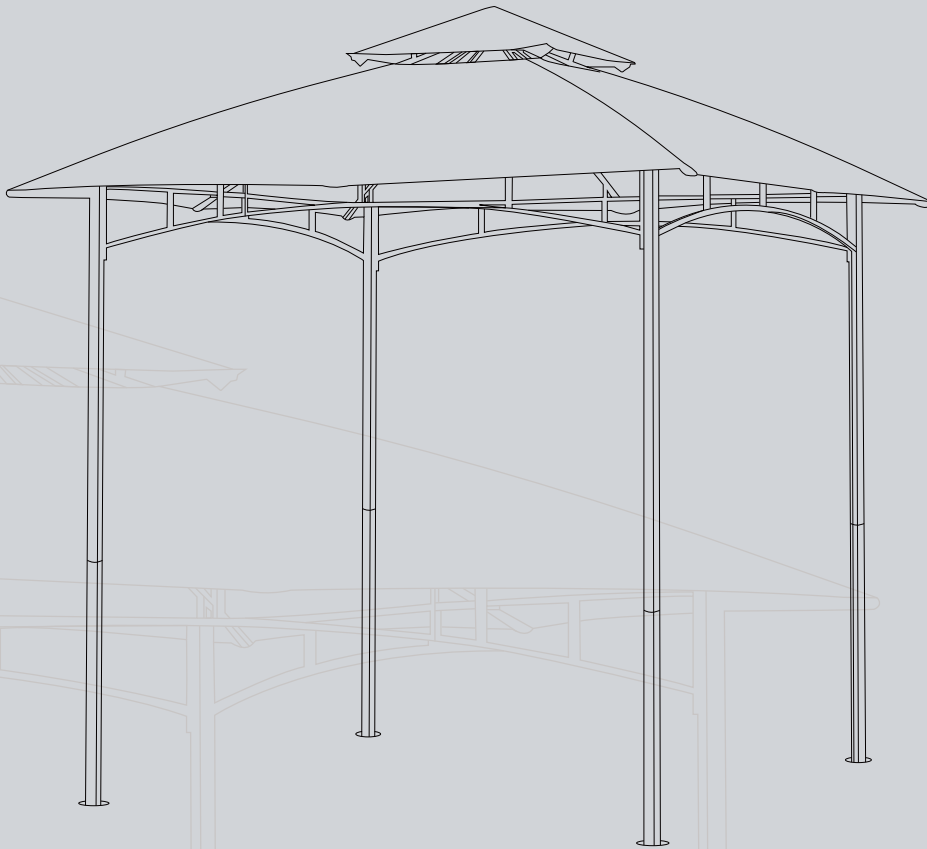

Product Information

Product Name	Patio Gazebo
Color	Dark Gray
Top Material	Riplock Fabric
Bracket Material	Alloy Steel
Specifications	10 ft x 12 ft
Applicable Season	Four Seasons
Applicable Venue	Backyard ,Garden ,Courtyard , Patio and Lawn

P6-6 X1  C-3 X4  E-3 X4 
P7-6 X1  D X40+8 

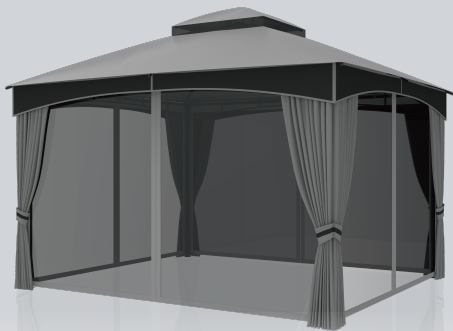

TP10

P6-3 X1 
P7-3 X1 



TP15

P6-3 X1  C-3 X4  D X40+8 
P7-3 X1 



TP16

P6-9 X1  F-9 X2 
P7-9 X1 

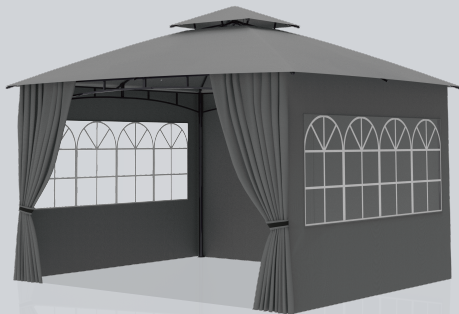

TP34

P6-6 X1  F-6 X2 
P7-6 X1 

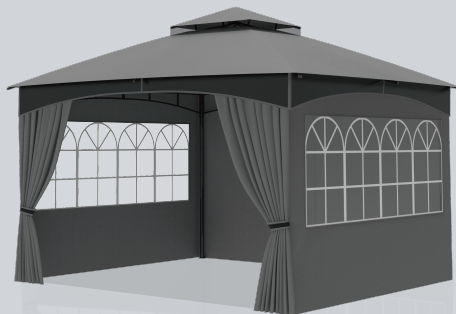





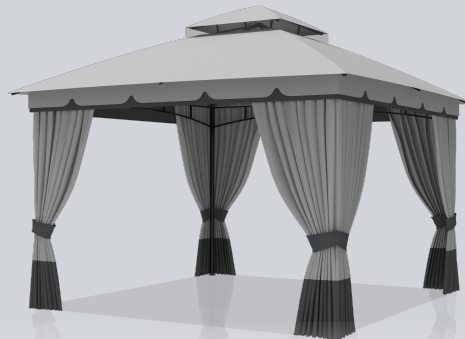





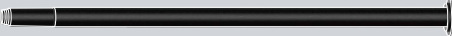
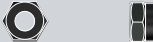

TP35

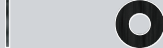
P6-6 X1  F-3 X4 
P7-12 X1 

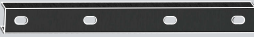
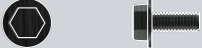



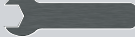







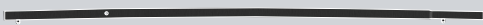

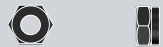

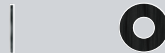
TP40

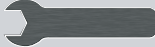
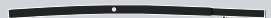
Parts Of Frame

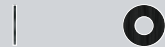
Part#		Qty	Part#		Qty
A1		4	EE		8
A2		4	FF		20
B-3		4	GG		20
B-4		4	HH		4
AA		16	II		8
BB		16	JJ		2
CC		4	NN		2
DD		8			

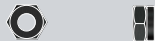
Parts of Top

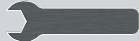
Part#		Qty	Part#		Qty
P1		4	P8-2		1
P2-3		4	CC		4
P2		4	FF		4
P3		4	GG		4
P4-3		2	JJ		2
P4-4		2	KK		8
P4		4	LL		8
P5		8	MM		8
P9		1	NN		2

Parts List

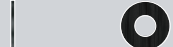
Part#			Qty
AA	M6x12		16+2
BB	M6x28		16+2
CC	M6x45		8+2
DD	M5x40		8+2
EE	M5		8+2
FF	M6		24+4
GG	M6		24+4
II			8
JJ	M6		2
KK	M5x32		8
LL	M5		8
MM	M5		8
NN	M5		2

Recommended number



Needed for assembly

(The following tools are not included)

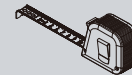
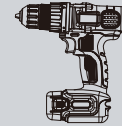

Safety Tips

1. If any parts are missing, broken, damaged, or frayed, **do not use this product until repairs have been made and/or replacement parts have been installed.**
2. Place the item on a **stable** and **level** surface.
3. Do not use or store this item near open **flames** or **flammable/combustible chemicals.**
4. Do not attempt to assemble this item under the following circumstances:
 - (1) **Drunk**
 - (2) **Inclement weather**
 - (3) **Lack of tools or parts**
 - (4) **Without assistance**
5. **Secure** all bolts, screws and knobs firmly before use.
6. Ensure that all bolts, screws, and knobs are securely tightened **every 90 days.**

Inspection And Acceptance

After the installation of the gazebo is completed, it needs to be inspected to ensure that all functions are normal and the structure is safe. Here are the steps to check and accept a patio gazebo:

1. **Gazebo:** Check that the gazebo is in good condition, with no visible scratches, damage or stains. Does the color and material of the gazebo match the description at the time of purchase.
2. **Parts and Hardware:** Check that all parts and tools are in accordance with the instructions.

Feel free to contact the customer service team if you have any questions. We will provide you with a satisfactory solution!

Step 1

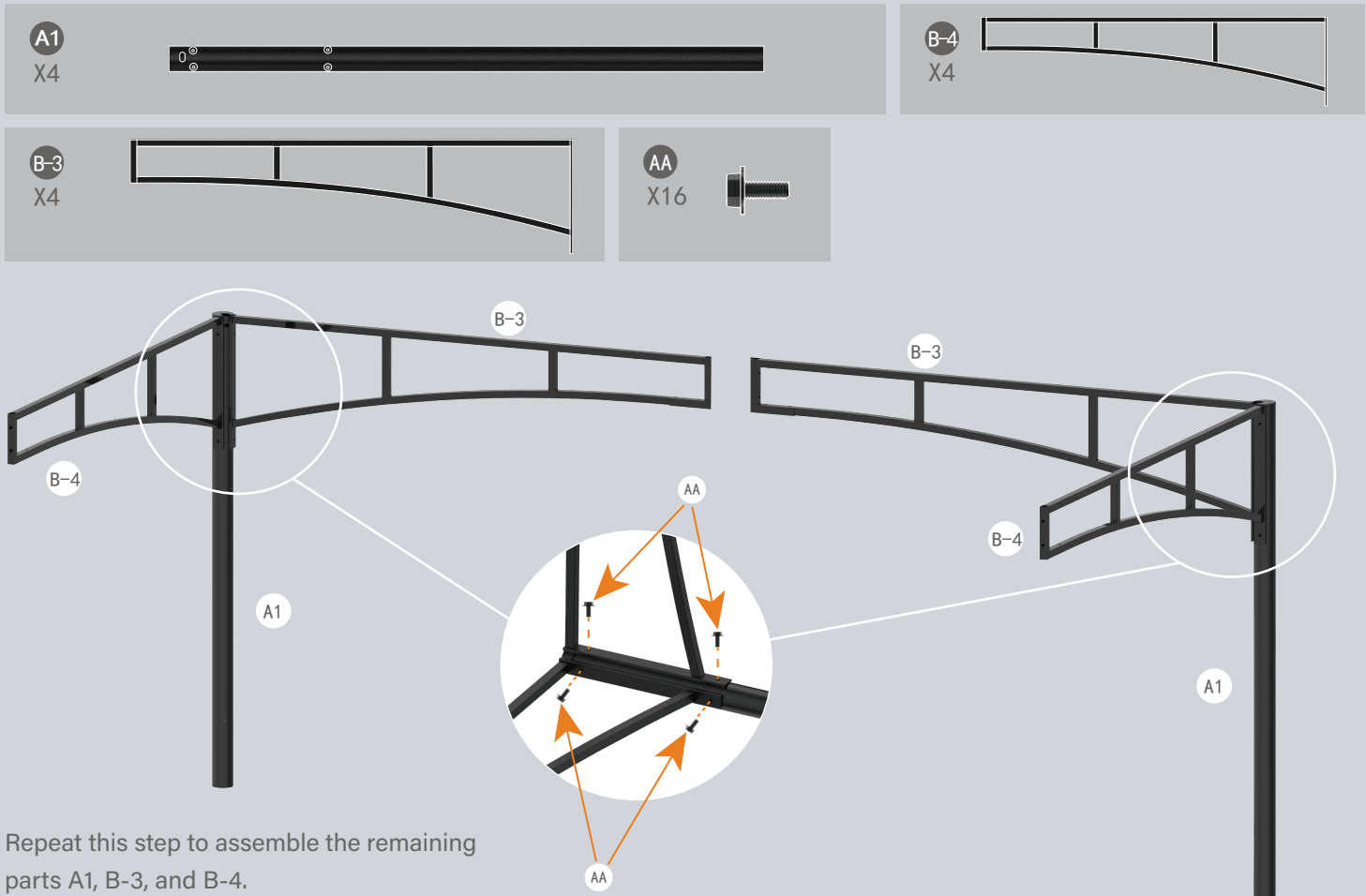

Repeat this step to assemble the remaining parts A1, B-3, and B-4.

Step 2

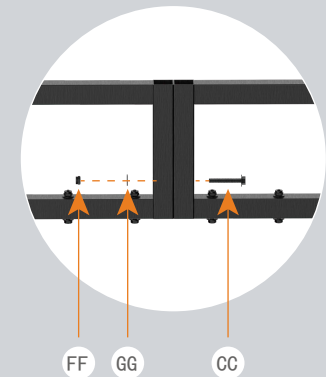
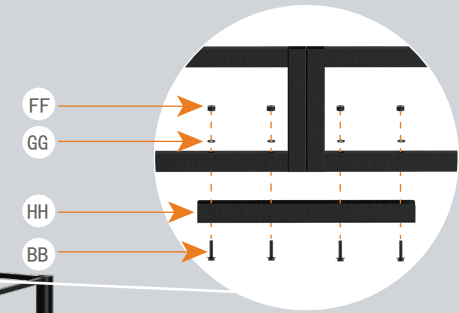
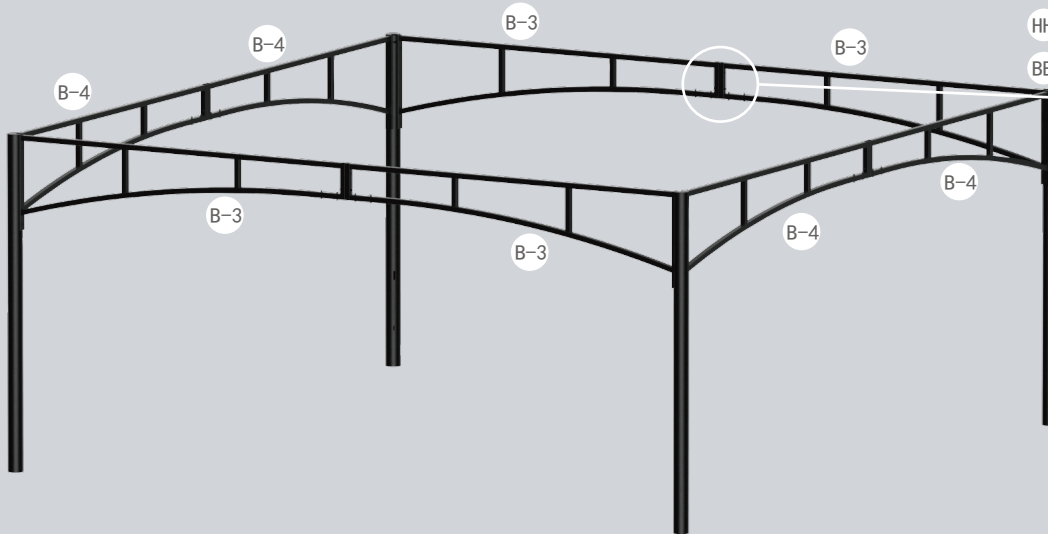
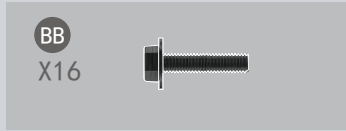
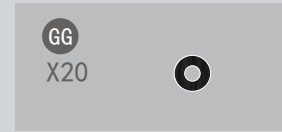
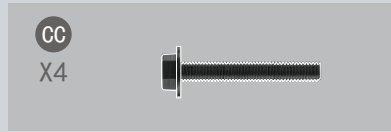
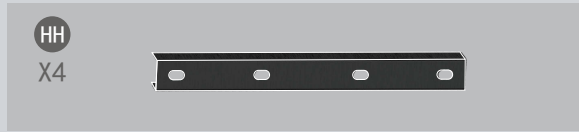

Connect the four sections that were installed in step 1 together as shown in the figure.

Step 3

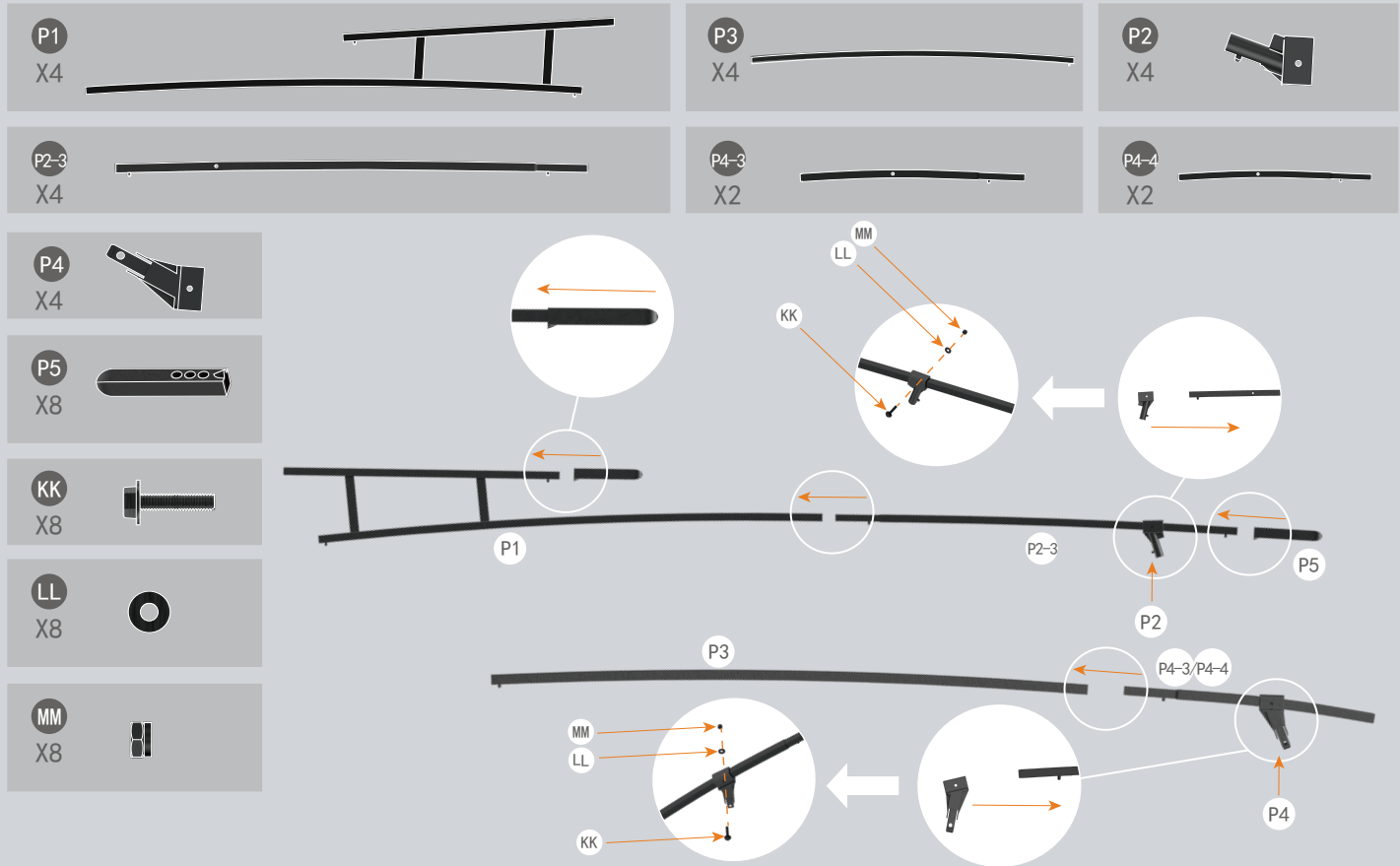

Repeat this step to assemble the remaining parts P1, P2-3, P2, P5, P3, P4-3/P4-4, and P4.

Step 4

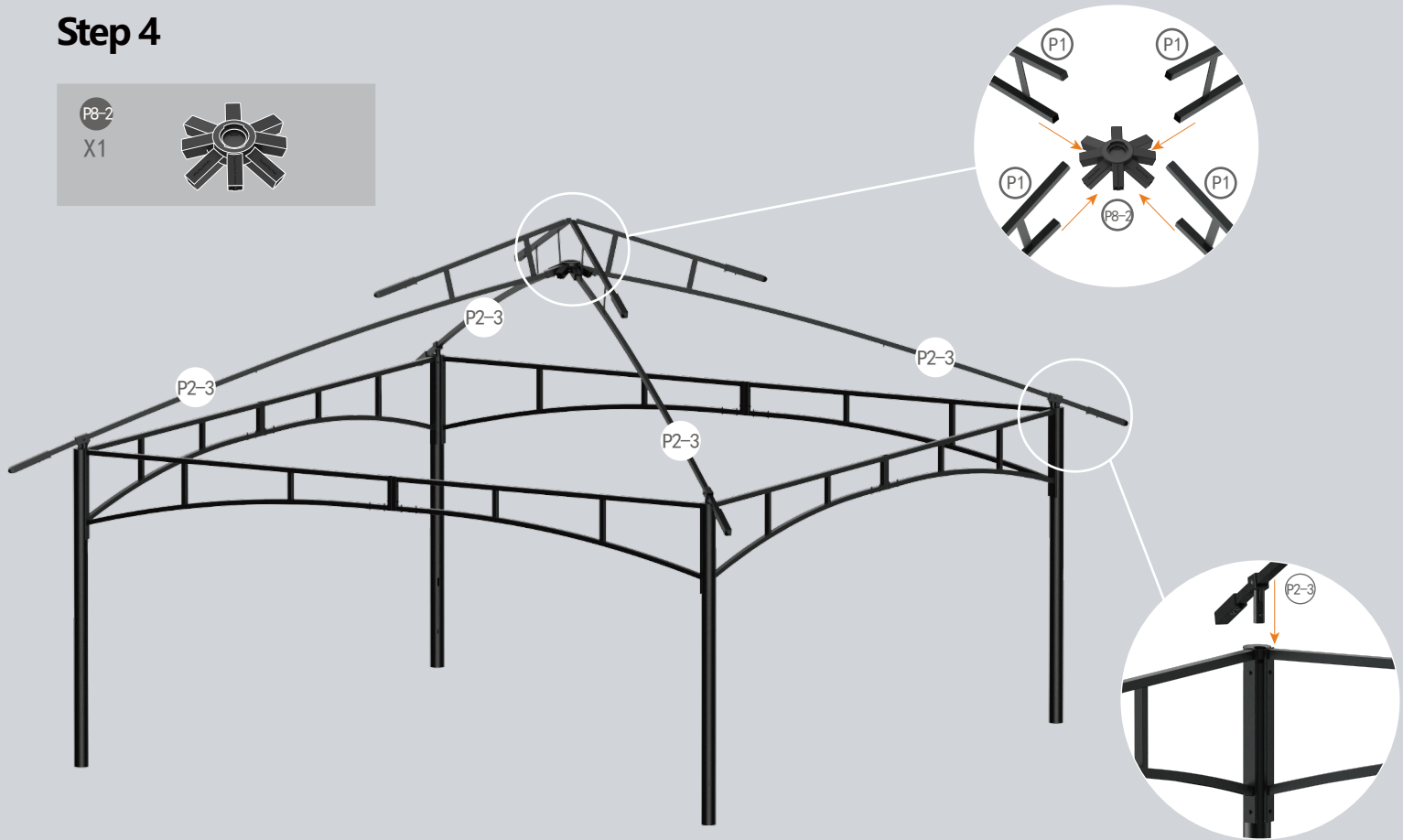

Connect the two sections installed in Steps 2 and 3 together as shown in the figure, and then link the part P8-2 at the top.

Step 5

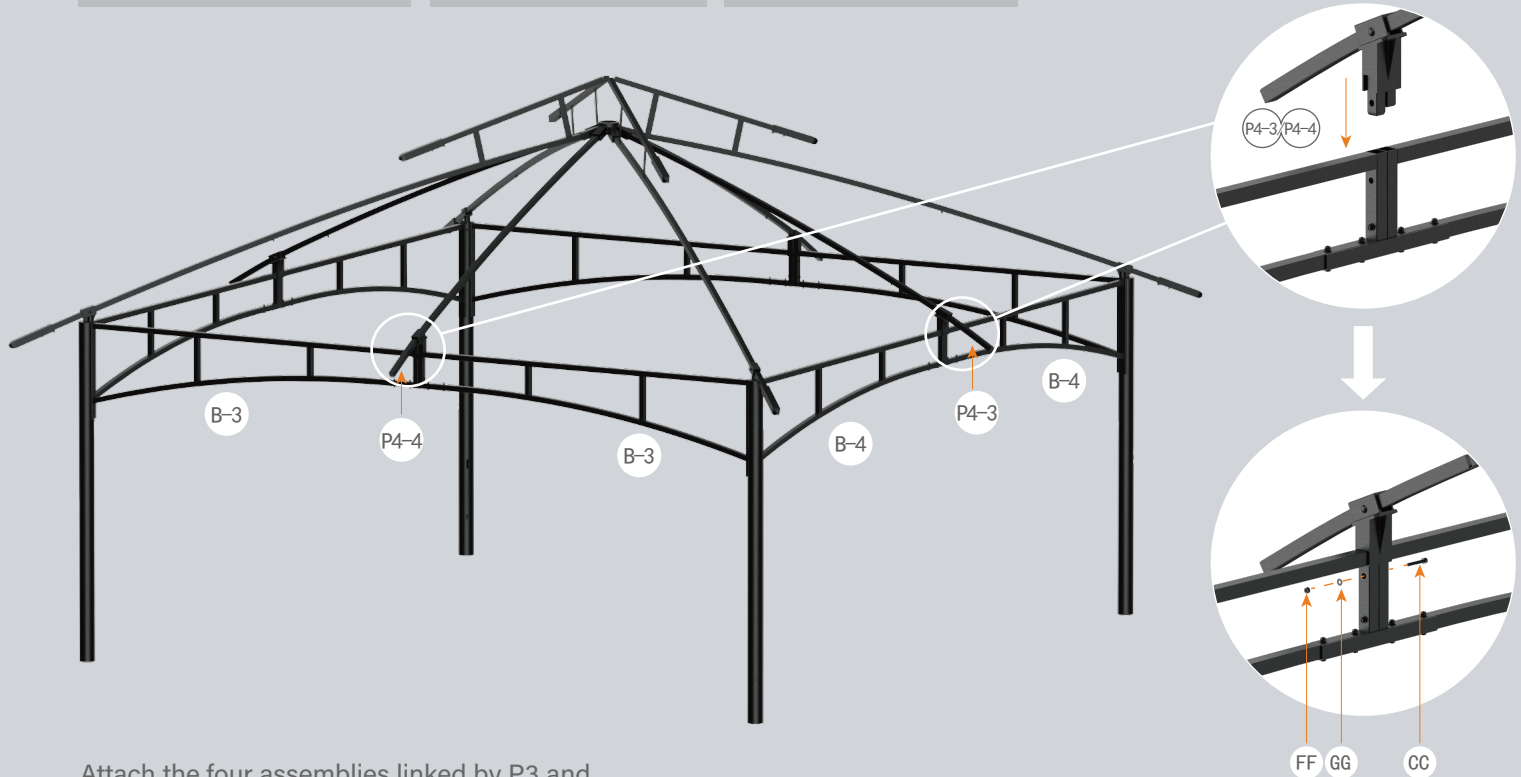
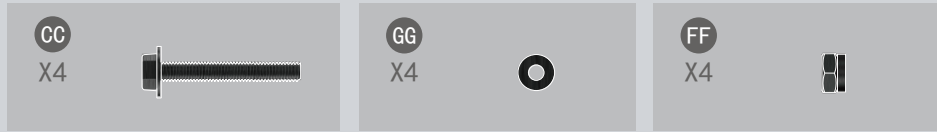

Attach the four assemblies linked by P3 and P4-3/P4-4 to the top of the four sides as shown.

Step 6

P9

X1

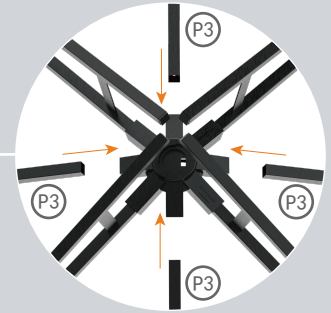
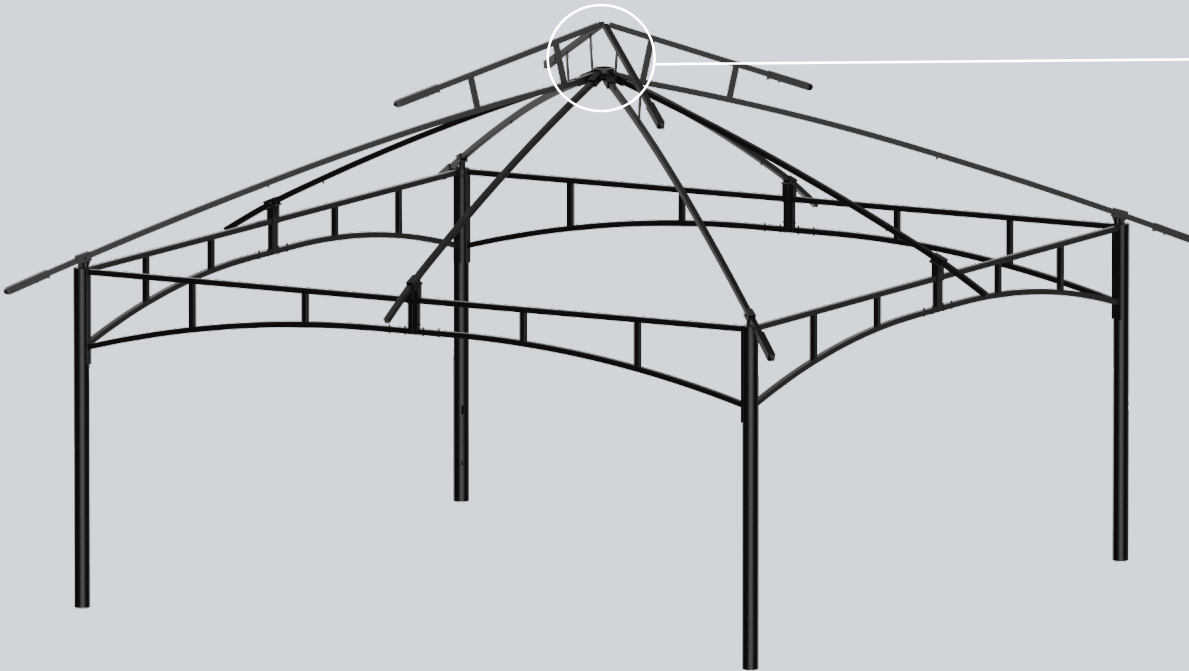

Plug P3 into P8-2, and then install P9.

Step 7

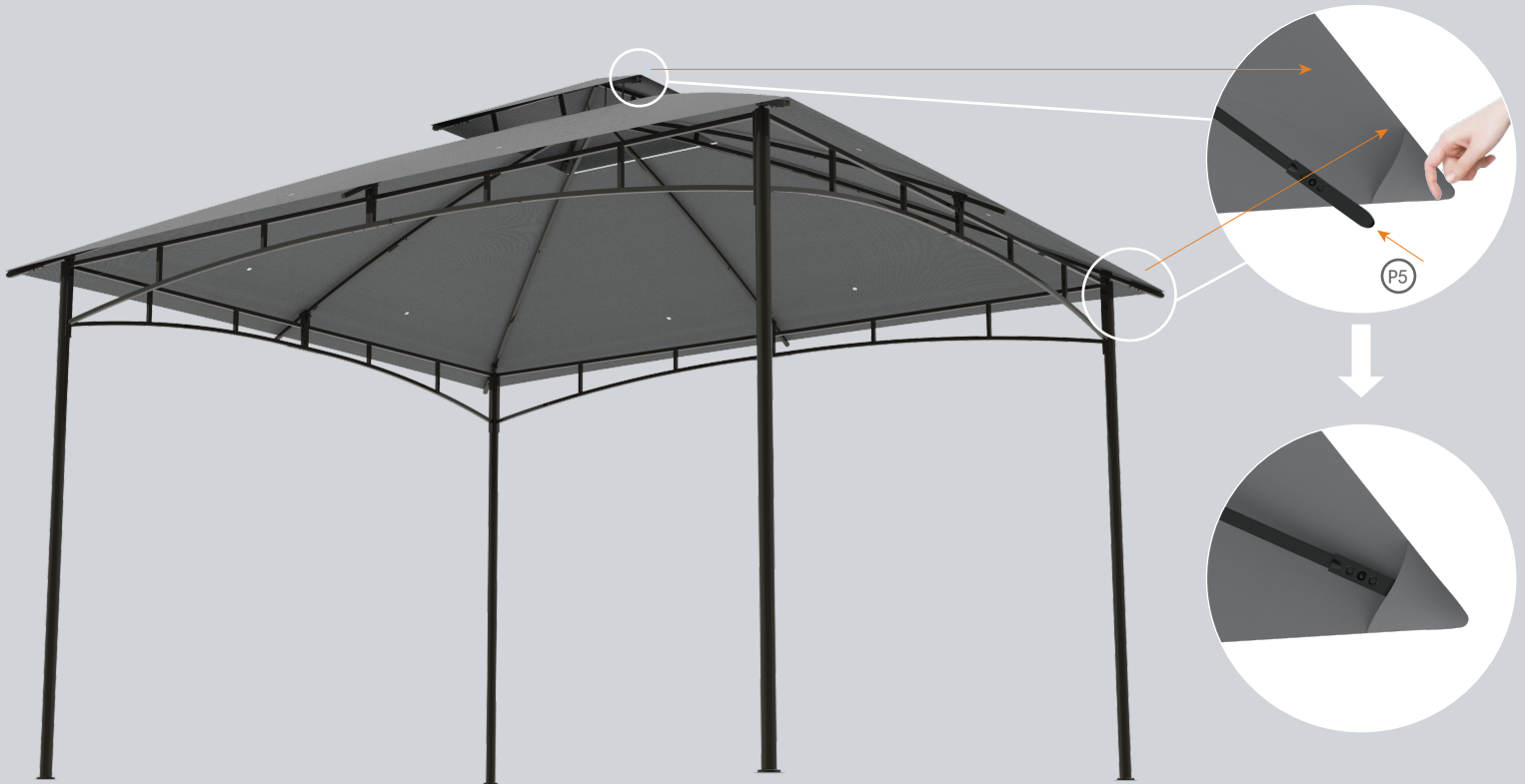

Install the two tops on the frame as shown and extend it fully.

Step 8

A2

X4

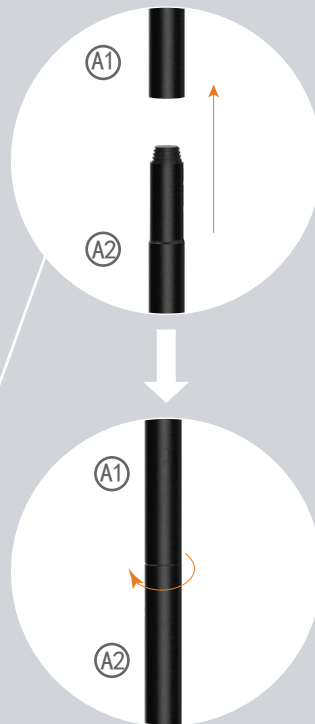
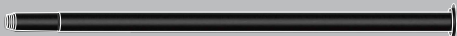

Step 9

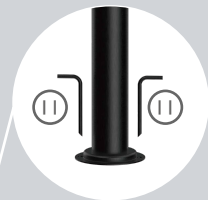
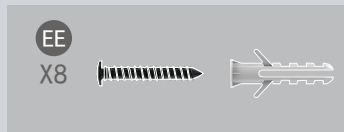
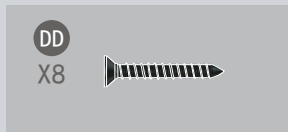

Applicable to ground scenarios

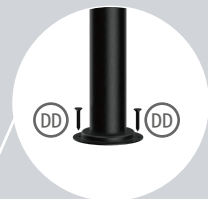

Applicable to plank scenarios

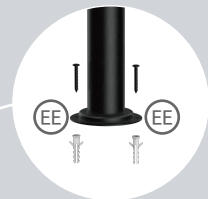

Applicable to concrete floor scenarios

User's Manual

Matters Needing Attention

1. **Weather Factors:** In extreme blizzard weather, please clear the top of the snow in time.
2. **Maintenance:** Please paint the metal parts regularly to extend the service life of the gazebo.
3. **Periodic Inspection:** Tighten all screws and connecting parts regularly.
4. **Stability and Sturdiness:** Be sure to nail the bottom of the four legs to make the gazebo more stable and Serviceable.

By following the above recommendations, you can have a longer, more reliable and comfortable experience with your patio canopy.

Common Problems And Solutions

1. How should the gazebo cope with **extremely blizzard weather**?
 - Clear the top of the snow in time.
2. What if parts or hardware are **lost** during installation?
 - Please contact customer service promptly and stop using or installing the gazebo before the parts or tools arrive.
3. What if the gazebo is **damaged** during use?
 - Please stop daily use immediately to ensure the safety of you and your family, contact customer service, provide pictures of the damage, and repair the gazebo under the guidance of customer service. Make sure the gazebo is in good condition before you reuse it.
4. How often is it recommended to **paint** the metal parts?
 - Every three months.
5. Can Metal Frame be **drilled** and **modified** at will?
 - We do not recommend this. Because this will affect the stability of the entire structure and cause certain security risks.

After-sales Service

1. Free return within 30 days.
2. Free replacement is available within 60 days.
3. Products need to be returned in their original packaging.
4. If the product is damaged, contact customer service promptly and provide relevant pictures.
5. Refunds that have been processed will generally be returned to the original account within 5-10 business days.
6. If you do not receive the product within the effective time, contact customer service to resolve them in a timely manner.
7. If you find something was missing during the assembly process, please stop the installation first, then take a picture of the manual and mark the missing part, and then contact our customer service. They will provide you with the best solution.
8. If you find that the product is aged or damaged during use and would like to purchase a replacement, please contact our customer service and we will provide you with the most cost-effective replacement solution.

Product Maintenance

1. **Regular Cleaning:** The top can be rinsed with a hose, and the columns can be wiped with a damp rag.
2. **Periodic Inspection:** Check screws and connecting iron parts for loosening and support structures for breakage. If yes, contact customer service in time and repair under the guidance of customer service.
3. **Protection From Extreme Snowstorms:** Clear the accumulated snow at the top in time to reduce the load.
4. **Maintenance Of Metal Parts:** The Metal parts need to be regularly painted to prevent rot and rust.

Disclaimer

Thank you for choosing our gazebo! To protect you and your family, please read and strictly follow the following items:

1. During assembly and use, be careful about safety and **follow** product **instructions** and **safety tips** to avoid accidents.
2. If the product is **damaged** as a result of **human action** or **weather**, **stop using** it immediately and **contact** our **customer service** promptly.
3. If the gazebo cannot be used properly due to the force majeure factor, we will not be liable for the losses incurred.
4. Please make sure that your use of the gazebo **does not interfere** with the normal life and work of others. Please **schedule your time** properly and avoid setting up and using the gazebo during other people's breaks.
5. Please **observe** the **local laws** and **regulations** and set up and use the gazebo according to the rules. Be sure to follow the requirements for erecting and using a gazebo if there are special requirements in local laws and regulations.
6. Please take care of the surrounding environment during the erection and use of the gazebo to avoid causing damage to surrounding buildings, facilities and the natural environment.
7. Please **check** the structural and safety condition of the gazebo **regularly**, and if you find anything **out of the ordinary**, **repair** or **replace** it promptly. If you are not sure how to inspect or repair it, please contact our customer service.
8. Please **respect** the **legitimate rights** and **interests of others**. If you spot someone entering your gazebo area without authorization, stop using the gazebo immediately and report it to the appropriate authorities.

We sincerely hope that you can fully enjoy the comfort and convenience when using the canopy, and at the same time ensure the safety of you and others. If you encounter any problems during the use, please feel free to contact our customer service, we will be happy to serve you.

MORE PRODUCTS



TA55



CT07



TP10



UB03

MORE PRODUCTS



UB02



AJ18



TB51



TD42

MORE PRODUCTS



TP01



SK01



UB04

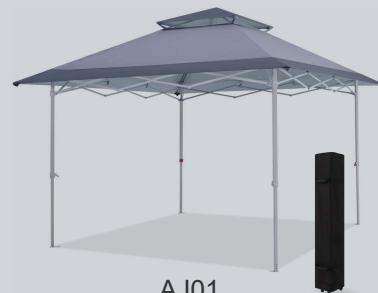

AJ01

Embrace the Joys of Life

